

160096 Dimensions

Overall Width w/ Trim: 28-7/16"
(Rough Opening: 26-3/16")

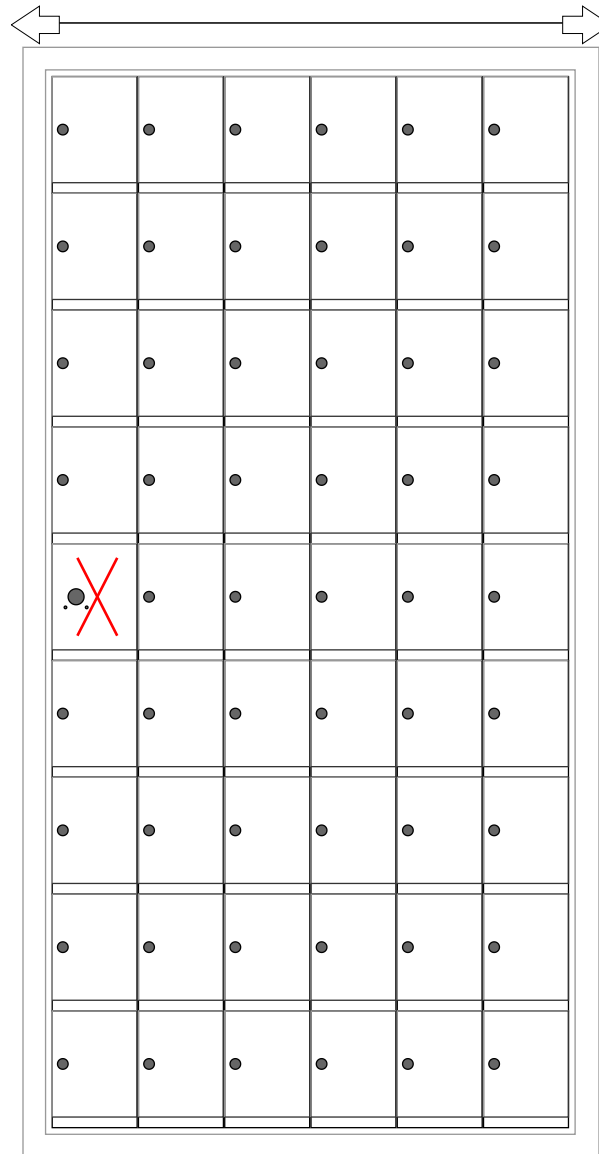

Side View

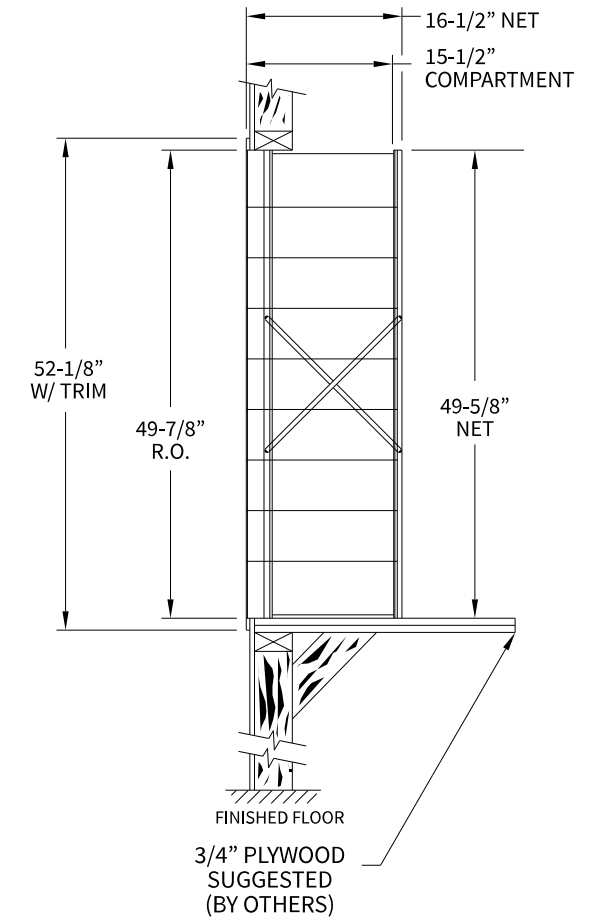

160096

Configuration Details:

- 1. **Product Type:** 1600 Horizontal
- 2. **Installation:** Front-load, Recessed Mount
- 3. **Finish:** Anodized Aluminum
- 4. **Locks:** Standard Cam Lock, 2 keys
- 5. **Door Id:** tbd

Matching standard snap-on trim included

Models Used:

(1) 160096

DO NOT SCALE OFF DRAWING

Door Sizes Used:

(53) 1600 1x1 Compartment
(1) 1x1 Master

ELEVATION: 160096 | **MAILBOXES:** 53 |

PROJECT NAME: 1600 Series Mailbox

DRAWN BY: FLORENCE

AF FLORENCE
manufacturing company

5935 Corporate Drive • Manhattan, KS 66503
www.florencemailboxes.com • 800.275.1747

A GIBRALTAR INDUSTRIES COMPANY

DATE: 01-15-2016

P.O. NO:

SCALE: NONE

QUOTE NO:

DRAWING NO. WEB-1932

SHEET 1 OF 1