

**FLORENCE**  
CORPORATION

CALL US  
800.275.1747

VISIT US ONLINE  
FlorenceMailboxes.com

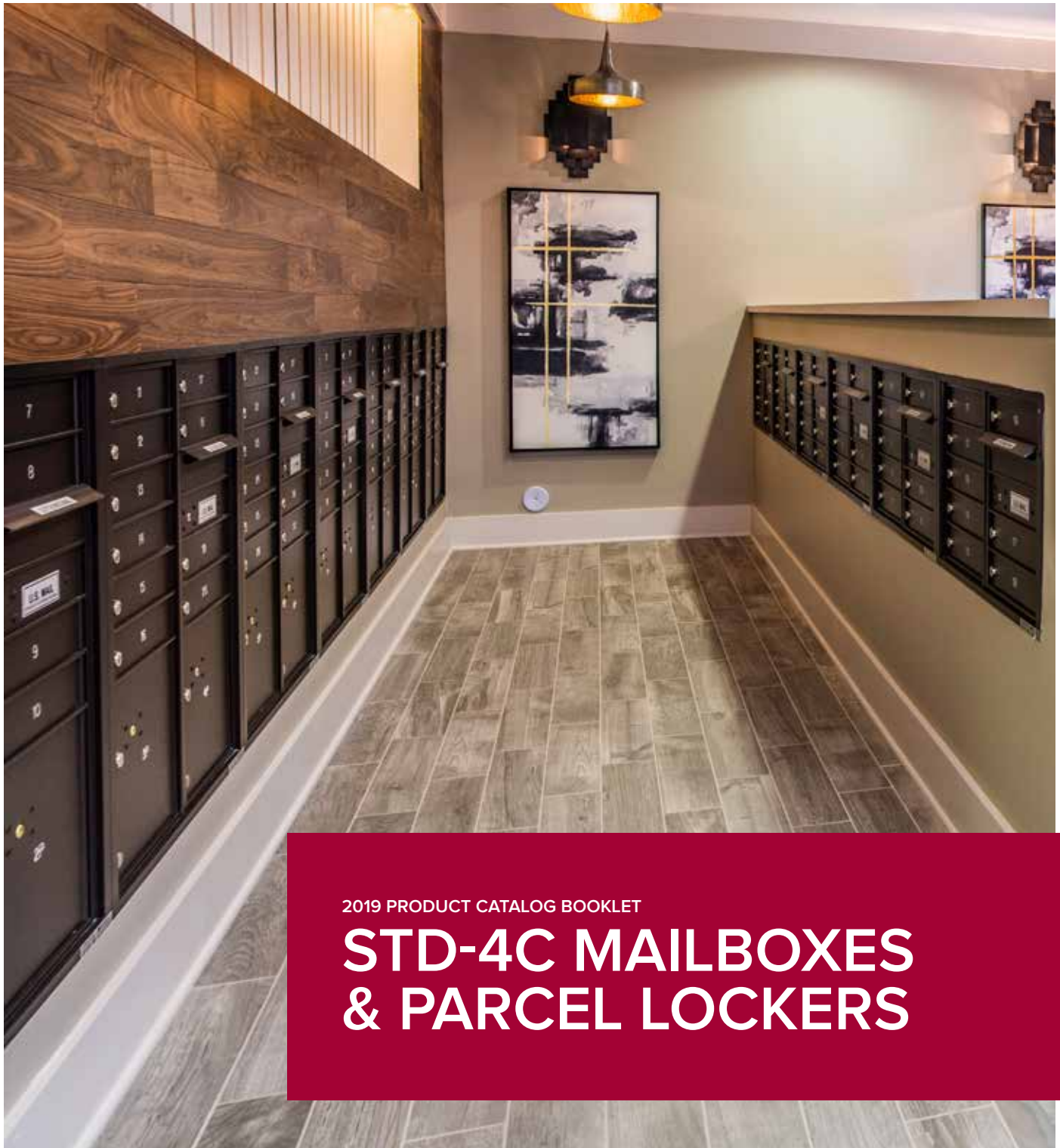

2019 PRODUCT CATALOG BOOKLET

# STD-4C MAILBOXES & PARCEL LOCKERS

# STD-4C Mailboxes & Parcel Lockers

FLEXIBILITY TO MEET YOUR NEEDS

versatile™  
4C Mailbox  
Suites



Versatility is the key to good design when planning for single or multifamily residential or commercial projects

135 preconfigured designs plus customizable configurations make it easy to design a centralized mail area just right for your project

USPS Approved and ADA Compliant designs are critical components of a functional mailroom

Online resources provide a design configurator, BIM models and specifications easily accessible for download into your project plans

Secure solutions for mail and package delivery are important to residents

Florence Dealers provide turnkey solutions, integrating USPS Approved STD-4C Mailbox Suites into your next project







From ordinary to visionary.

Visit *Architect Toolkit* for  
more ideas and resources.  
[www.florencemailboxes.com/  
architecttoolkit](http://www.florencemailboxes.com/architecttoolkit)

# versatile™ 4C Mailboxes & Parcel Lockers

## FEATURES & OPTIONS

### MAIL, OUTGOING MAIL & PARCEL LOCKER COMPARTMENT SIZES

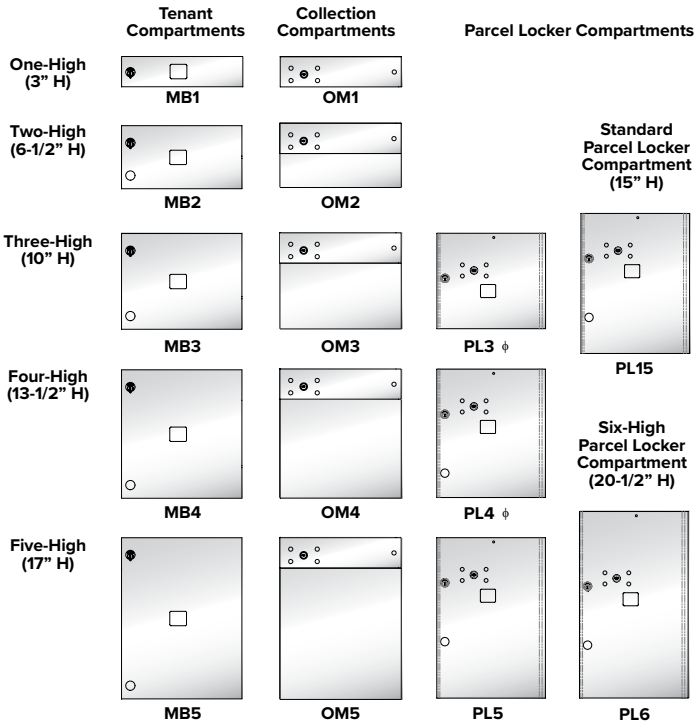

$\phi$  For Private Delivery, unless parcel locker ratio exceeds requirement - see below for full details

$\phi$  To satisfy the USPS STD-4C 1:10 parcel locker to mailbox ratio requirement, parcel lockers (PL) must meet a minimum compartment height of 15". If the total number of PL in the mailbox installation exceeds the 1:10 requirement, smaller PL may also be included. For example: If a project requires 200 mailboxes, than at least 20 PL with a minimum size of 15"H x 12"W x 15"D must be included. But, if you add more than 20 PL to the 200 mailboxes, than you may also choose to incorporate some smaller PL into the installation. Be sure to note PL height when utilizing only one 4C module type in your entire installation as not all built-in lockers are 15" H and may require addition of parcel only modules to meet the 1:10 requirements (e.g. 4C13D-16).

### DOOR ID OPTIONS

**Decals:** All 4C modules come standard with silver adhesive decals which are 1-1/2"H x 1-3/4"W. Black lettering can contain up to five characters (alpha and numeric) per decal.

**Engraving:** Custom engraving utilizes the USPS Standard US Block font and is 3/4" tall. All engraving can include up to 12 characters on one or two lines.



[florencemailboxes.com/4C](http://florencemailboxes.com/4C)

### COLOR OPTIONS

Customize your 4C module with one of eight different architectural color options, all in a durable, powder coat finish.



Antique Bronze (AB)    Black (BK)    Dark Bronze (DB)    Gold Speck (GS)



Postal Grey (PG)    Sandstone (SD)    Silver Speck (SS)    White (WH)

Colors shown are representative of the actual powder coat finish but are limited by printing conditions and may vary slightly from finished product.



AVAILABLE IN 12 DIFFERENT HEIGHT OPTIONS

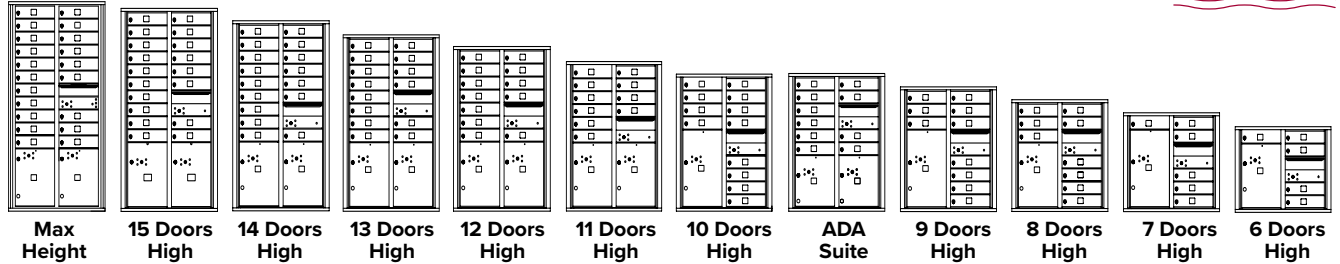

The reference module images and charts on the following pages show the proper installation heights for Florence's versatile™ 4C mailboxes and parcel lockers to help your project comply with USPS installation and accessibility codes. Drawings shown are for your quick reference only. See following pages for details.

OPTIONAL ACCESSORIES



**Collection Boxes** See page 16

These secure collection modules complement your mailbox installation and are designed for either postal or private collection of items such as x-rays, DVD/Blue Ray, books, etc.



**Recycling Bins** See page 17

Keep the centralized mail center tidy by providing receptacles for the disposal of unwanted mail, or create a recycling center with these matching modules.



**Key Keepers** See page 34

Key Keepers securely provide access to important keys to only those authorized to use them. Prepared to accept a postal lock installed by local postal officials, key keepers may be converted to locks appropriate for private uses so staff can gain access to controlled areas.



**Directories** See page 35

These surface-mounted directories can be used independently or installed next to any mailbox installation to neatly and alphabetically list the names of your residents. A clear plastic window, metal back plate, and blank ruled name cards are included with each directory.

TOP/SIDE VIEWS FOR ALL HEIGHTS

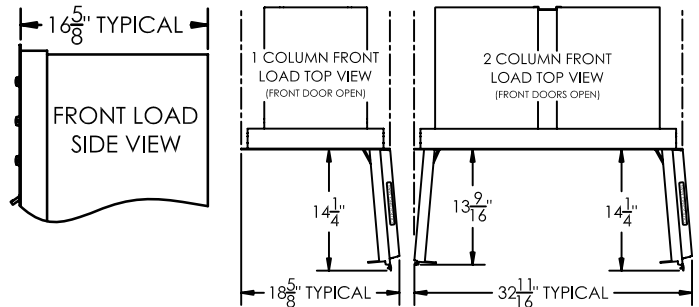

## Installation Alternatives

### OPTIONS FOR STD-4C MOUNTING

#### RECESSED MOUNT

The most common way to install the 4C modules is into a wall. Florence makes installation easy by providing a Multi-Unit Connector Kit (MUCK) for each specified module. The MUCK eliminates the need for studs and pulls the units together tightly, reducing any potential gaps between modules.



#### SURFACE MOUNT

Single or double-wide 4C modules can be installed flush on a wall when utilizing the surface-mount collar option. This installation alternative is ideal for settings with limited wall depth. The collar is easy to assemble with a slotted back which is designed for ease of installation. The collars are all aluminum construction in rugged, weather-resistant powder coat finishes and can be used indoors or out.



SM##D SM##S  
(Note: ## = selected suite height, e.g. SM14D)



#### PEDESTAL MOUNT

Mounting a USPS Approved 4C module on a pedestal is not a Postal approved installation alternative, but is an excellent solution for any private delivery application. Pedestals are designed to ensure the selected module is installed at a standard accessible height. For pedestal mounted module numbers, simply add "P" to the end of the front-load 4C module numbers in the 4C suites section on pages 20-31



## PRODUCT DESIGN & SECURITY FEATURES



Interlocking, overlapping seams to prevent prying



Heavy duty tenant cam lock with three keys



Standard decals or 3/4" H engraving

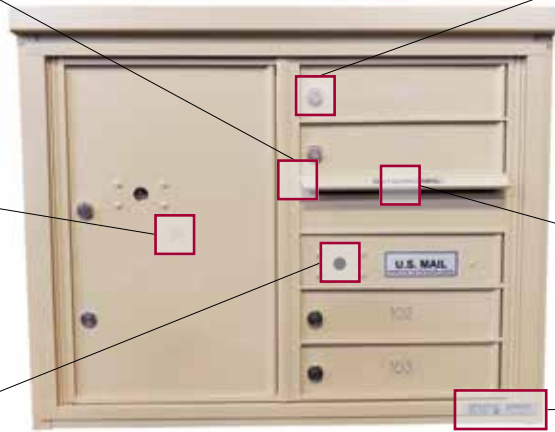

Integrated Outgoing Mail Slot with weather protection hood



Solid aluminum integrated outgoing mail collection compartment prepared for USPS installed Arrow Lock



Product and manufacturer ID serial tag



Fully integrated parcel locker(s) with key trapping lock

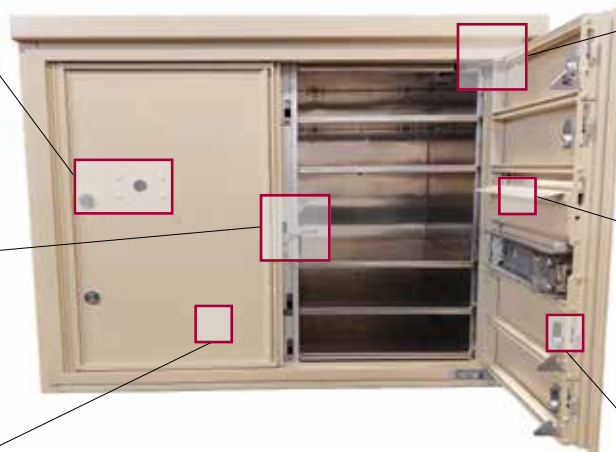

Stainless steel hold open door catch on each side of master gate



Easy release handle to open master gate



Aluminum comb prevents mail fishing in outgoing mail collection compartment



Rugged, weather-resistant powder coat finish



Heavy duty cam latches through frame for added security

## Collection Boxes FOR LETTERS OR PACKAGES

Use this secure product for the collection of outgoing mail in the form of letters or small packages. The patent pending hopper mechanism and collection box door ensure contents remain safe and secure. Designed to be suitable for indoor or outdoor use, it can be mounted on a pedestal, in a wall or on the surface of the wall.

### STANDARD FEATURES

- Collection box units can be installed recess- or surface-mounted on a wall or with a pedestal
- Units designed to meet ADA/DOJ, ICC/ANSI, and IBC compliance for maximum 48" door access when installed 14-1/8" above the finished floor
- Industry unique designs seal off access to the main collection compartment when open to prevent mail fishing
- When open, collection door extends 5-7/16" from unit and seals off access to the main collection compartment. Once unit is full, collection door will not open to accept more items.

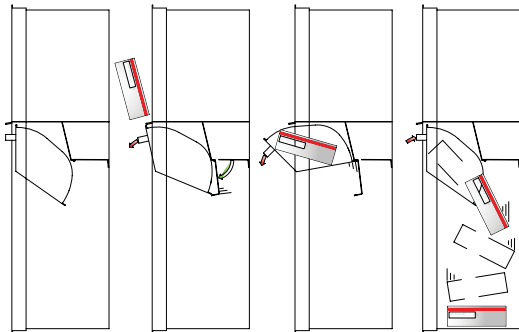

Pedestal mount collection boxes may be approved for USPS collection if local postal officials authorize use on location.



4C10S-HOP



### COLOR OPTIONS

Customize your versatile™ Collection Boxes with eight different architectural powder coat finishes.



Antique Bronze (AB)    Black (BK)    Dark Bronze (DB)    Gold Speck (GS)



Postal Grey (PG)    Sandstone (SD)    Silver Speck (SS)    White (WH)

Colors shown are representative of the actual powder coat finish but are limited by printing conditions and may vary slightly from finished product.



## Collection Bins FOR WASTE/RECYCLING

These bins are designed as part of the versatile™ 4C mailbox line and are the perfect complement to your centralized mail center. Keep the area tidy by providing receptacles for the disposal of waste, or create a standalone recycling center for the convenience of your residents.

### STANDARD FEATURES

- Constructed of heavy gauge aluminum and stainless steel components
- Included interior collection receptacle(s) constructed of all recycled materials
- Master door includes 5-pin cam lock with three keys
- Door flap in brushed stainless steel with pre-printed decals: WASTE, TRASH, PLASTIC, GLASS or PAPER
- Recessed-mount

### OPTIONAL FEATURES

- Custom door flap decals with up to 12 characters
- Powder coat finish door flap in coordinating color
- Eight powder coat color finishes
- Surface or pedestal mount

### DOOR FLAP DECAL OPTIONS

Choose from five standard decal options or create your own custom option with up to 12 characters.

TRASH WASTE GLASS PAPER PLASTIC



### COLOR OPTIONS

Customize your versatile™ Collection Bin with eight different architectural powder coat finishes.



Antique Bronze (AB) Black (BK) Dark Bronze (DB) Gold Speck (GS)



Postal Grey (PG) Sandstone (SD) Silver Speck (SS) White (WH)

Colors shown are representative of the actual powder coat finish but are limited by printing conditions and may vary slightly from finished product.

## ACCESSORY MODULES



### COLLECTION BOX SELECTIONS

Designed to coordinate with versatile™ 4C mailbox suites, select as many modules as needed for your project.



**Note:** Free-standing collection boxes for postal delivery must be pre-approved by local postal officials.

### BIN SELECTIONS

Florence is pleased to be the provider of versatile™ 4C trash/recycling bins. Designed to coordinate with the versatile™ 4C mailbox suites, select as many modules as needed for your project.



### MOUNTING OPTIONS

Three different mounting options provide greater flexibility in creating a collection box or recycling center to match an existing mailbox installation.

- Recessed-mount
- Surface-mount collar
- Pedestal-mount

See page 14 for more information on mounting options



 [florencemailboxes.com/4CPM](http://florencemailboxes.com/4CPM)

# Pedestal-Mounted 4C Mailboxes

## FLEXIBILITY FOR PRIVATE DELIVERY

With all the same features and options, security, and durability of the Florence wall-mounted versatile™ 4C modules, pedestal mounting adds greater flexibility to your project as it is not tied to USPS regulations. Designed to ensure every module is at a standard accessible height, pedestal-mount units come prepared with a master commercial lock to provide easy access to all compartments at once.

Ideal for centralized mail delivery applications where the USPS letter carrier delivers to a single location and the facility manager or entrusted individual then distributes the mail to the resident compartments.

### COLOR OPTIONS

Customize your 4CPM with one of eight different architectural color options, all in a durable, powder coat finish.



**Antique Bronze (AB)**    **Black (BK)**    **Dark Bronze (DB)**    **Gold Speck (GS)**



**Postal Grey (PG)**    **Sandstone (SD)**    **Silver Speck (SS)**    **White (WH)**

Colors shown are representative of the actual powder coat finish but are limited by printing conditions and may vary slightly from finished product.

### PRODUCT APPLICATIONS

- Military Housing
- Off-campus Student Housing
- On-campus Residence Halls
- Gated/Guarded Facility
- Book Collection
- Rent Payment Collection
- Multi-Media Drop Off
- Key Returns/Collection
- College Campus
- Private Medical Facility
- Financial Institutions
- K-12 Schools

### AVAILABLE IN 12 HEIGHT OPTIONS

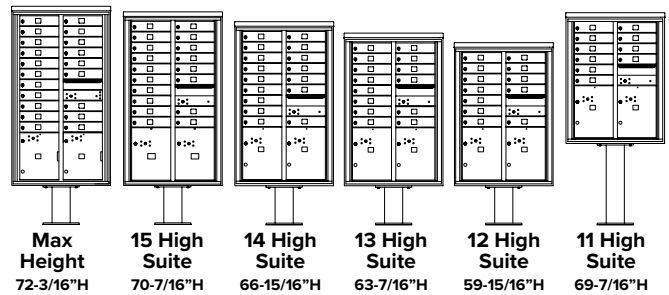

**Max Height** 72-3/16" H    **15 High Suite** 70-7/16" H    **14 High Suite** 66-15/16" H    **13 High Suite** 63-7/16" H    **12 High Suite** 59-15/16" H    **11 High Suite** 69-7/16" H

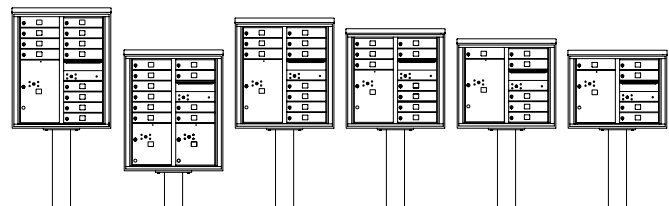

**10 High Suite** 65-15/16" H    **ADA Suite** 52-15/16" H    **9 High Suite** 62-7/16" H    **8 High Suite** 58-15/16" H    **7 High Suite** 55-7/16" H    **6 High Suite** 52" H

Overall pedestal-mount module dimensions: (Shown above) H x 32-13/16" W (Double) or 18-3/4" W (Single) x 17-3/4" D



## MAX HEIGHT SUITE

Actual: 56-1/2"H x 31-9/16"W (Double) or 17-1/2"W (Single) x 17"D  
Rough Opening: 55-9/16"H x 30-5/16"W (Double) or 16-1/4"W (Single) x 17"D

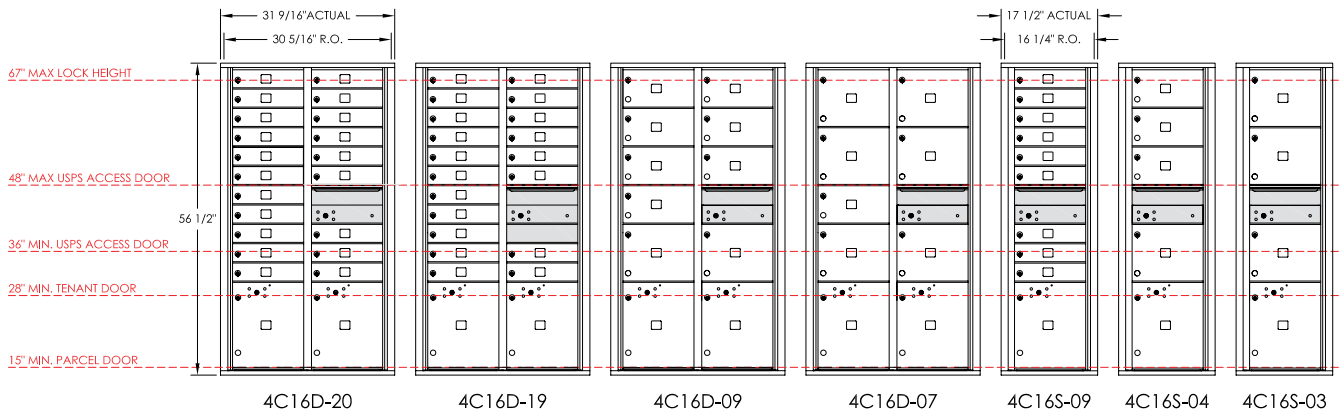

Floor

MODEL (COMPARTMENT TYPES)	4C16D-20 (20 MB1, 2 PL15)	4C16D-19 (19 MB1, 2 PL15)	4C16D-09 (7 MB2, 2 MB3, 2 PL15)	4C16D-07 (1 MB2, 6 MB3, 2 PL15)	4C16S-09 (9 MB1, 1 PL15)	4C16S-04 (3 MB2, 1 MB3, 1 PL15)	4C16S-03 (3 MB3, 1 PL15)
# Mailboxes (Total)	20	19	9	7	9	4	3
# Parcel Lockers (Total)	2	2	2	2	1	1	1
# Collection	1	1	1	1	1	1	1
# BINS	0	0	0	0	0	0	0
# Mailboxes Under 48"	8	7	3	3	3	1	1
Module Weight (lbs)	171	163	157	140	97	81	62

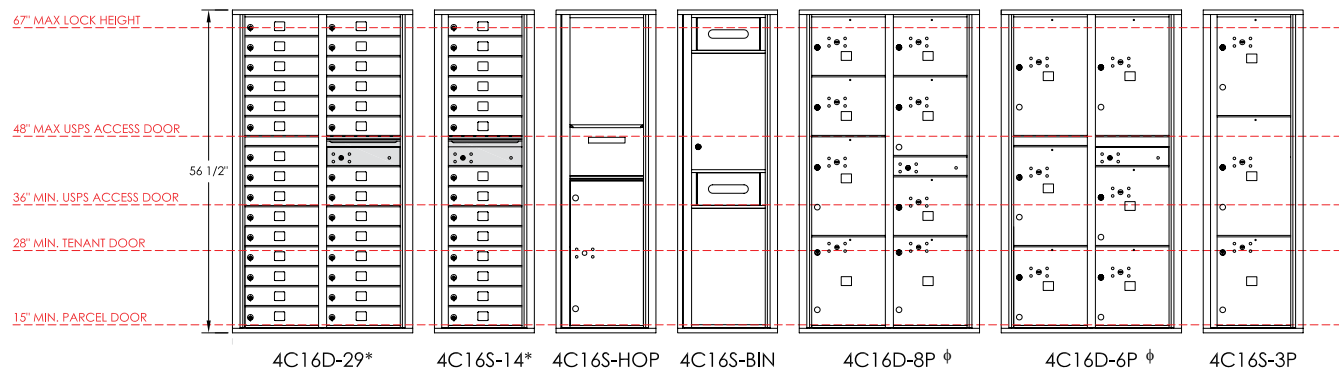

Floor

MODEL (COMPARTMENT TYPES)	4C16D-29* (29 MB1)	4C16S-14* (14 MB1)	4C16S-HOP	4C16S-BIN	4C16D-8P φ (4 PL3, 1 PL4, 1 PL5, 2 PL15)	4C16D-6P φ (3 PL4, 1 PL5, 2 PL6)	4C16S-3P (1 PL15, 1 PL5, 1 PL6)
# Mailboxes (Total)	29	14	0	0	0	0	0
# Parcel Lockers (Total)	0	0	0	0	8	6	3
# Collection	1	1	1	0	0	0	0
# BINS	0	0	0	2	0	0	0
# Mailboxes Under 48"	17	8	0	0	0	0	0
Module Weight (lbs)	170	96	76	65	113	105	58

### NOTES:

All standard 4C mailbox modules shown above are fully configurable; visit [florencemailboxes.com/configure](http://florencemailboxes.com/configure) to quickly and easily create your custom solution.

See page 12 for mailbox (MB) and parcel locker (PL) compartment size definitions and configurable options.

Modules noted with (\*) do not meet USPS installation specifications and are for private delivery; those noted with (φ) contain PL under the USPS required 15" tall - see page 12 for details.

Modules noted with a plus (+) meet Fair Housing ADA installation requirements.

All model numbers listed are for recessed-mount modules; add -P for Pedestal-mount modules at the end of the number.

## 15 DOOR HIGH SUITE

Actual: 54-3/4"H x 31-9/16"W (Double) or 17-1/2"W (Single) x 17"D

Rough Opening: 53-13/16"H x 30-5/16"W (Double) or 16-1/4"W (Single) x 17"D

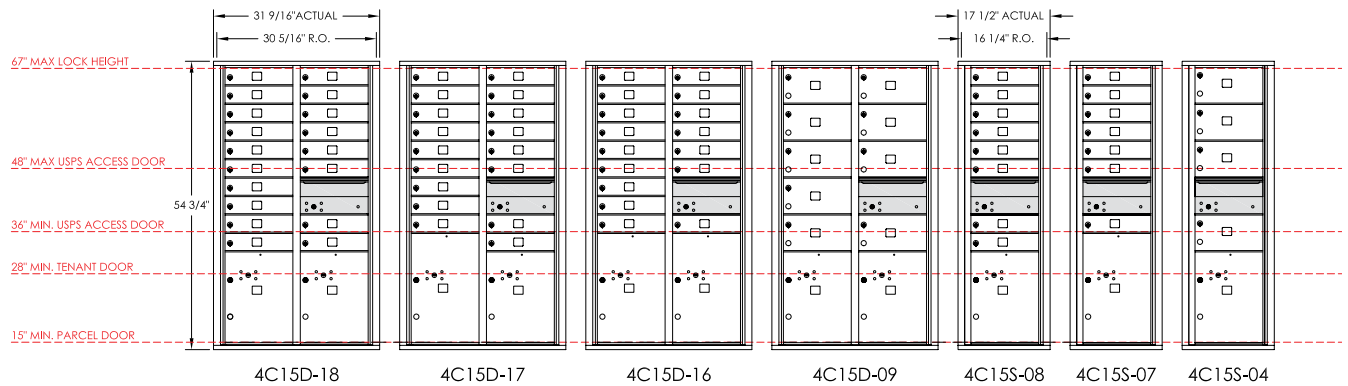

Floor

MODEL (COMPARTMENT TYPES)	4C15D-18 (18 MB1, 2 PL5)	4C15D-17 (17 MB1, 1 PL5, 1 PL6)	4C15D-16 (16 MB1, 2 PL6)	4C15D-09 (9 MB2, 2 PL5)	4C15S-08 (8 MB1, 1 PL5)	4C15S-07 (7 MB1, 1 PL6)	4C15S-04 (4 MB2, 1 PL5)
# Mailboxes (Total)	18	17	16	9	8	7	4
# Parcel Lockers (Total)	2	2	2	2	1	1	1
# Collection	1	1	1	1	1	1	1
# BINS	0	0	0	0	0	0	0
# Mailboxes Under 48"	8	7	6	3	3	2	1
Module Weight (lbs)	160	158	156	144	87	85	79

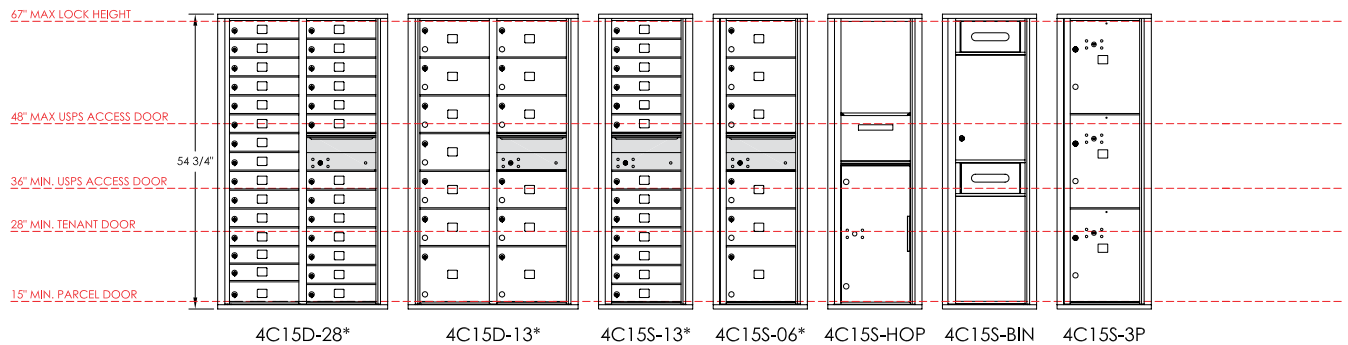

Floor

MODEL (COMPARTMENT TYPES)	4C15D-28* (28 MB1)	4C15D-13* (11 MB2, 2 MB3)	4C15S-13* (13 MB1)	4C15S-06* (5 MB2, 1 MB3)	4C15S-HOP	4C15S-BIN	4C15S-3P (3 PL5)
# Mailboxes (Total)	28	13	13	6	0	0	0
# Parcel Lockers (Total)	0	0	0	0	0	0	3
# Collection	1	1	1	1	1	0	0
# BINS	0	0	0	0	0	2	0
# Mailboxes Under 48"	18	7	8	3	0	0	0
Module Weight (lbs)	122	142	95	79	74	63	75

### NOTES:

All standard 4C mailbox modules shown above are fully configurable; visit [florencemailboxes.com/configure](http://florencemailboxes.com/configure) to quickly and easily create your custom solution.

See page 12 for mailbox (MB) and parcel locker (PL) compartment size definitions and configurable options.

Modules noted with (\*) do not meet USPS installation specifications and are for private delivery; those noted with (φ) contain PL under the USPS required 15" tall - see page 12 for details.

Modules noted with a plus (+) meet Fair Housing ADA installation requirements.

All model numbers listed are for recessed-mount modules; add -P for Pedestal-mount modules at the end of the number.

## 14 DOOR HIGH SUITE

Actual: 51-1/4"H x 31-9/16"W (Double) or 17-1/2"W (Single) x 17"D  
Rough Opening: 50-5/16"H x 30-5/16"W (Double) or 16-1/4"W (Single) x 17"D

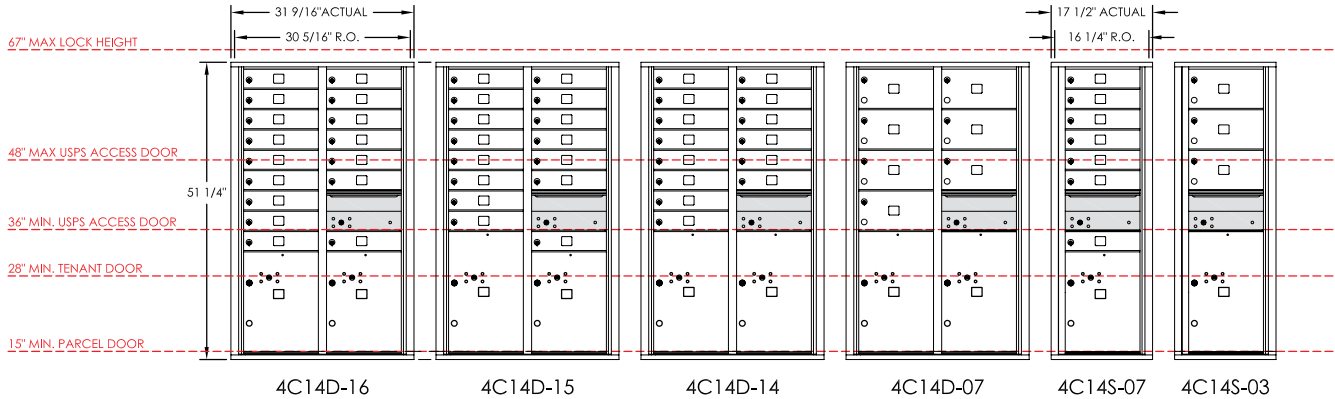

Floor

MODEL (COMPARTMENT TYPES)	4C14D-16 (16 MB1, 2 PL5)	4C14D-15 (15 MB1, 1 PL5, 1 PL6)	4C14D-14 (14 MB1, 2 PL6)	4C14D-07 (7 MB2, 2 PL6)	4C14S-07 (7 MB1, 1 PL5)	4C14S-03 (3 MB2, 1 PL6)
# Mailboxes (Total)	16	15	14	7	7	3
# Parcel Lockers (Total)	2	2	2	2	1	1
# Collection	1	1	1	1	1	1
# BINS	0	0	0	0	0	0
# Mailboxes Under 48"	8	7	6	3	3	1
Module Weight (lbs)	137	130	109	99	72	56

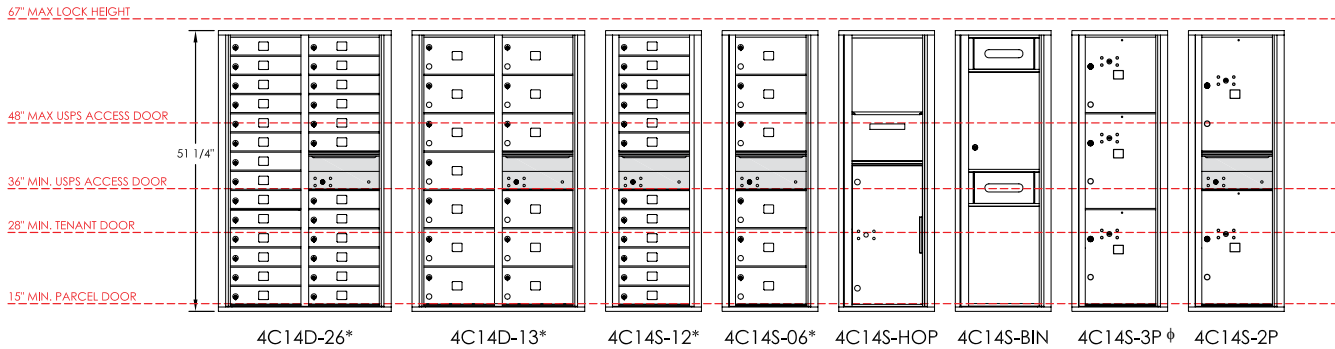

Floor

MODEL (COMPARTMENT TYPES)	4C14D-26* (26 MB1)	4C14D-13* (13 MB2)	4C14S-12* (12 MB1)	4C14S-06* (6 MB2)	4C14S-HOP	4C14S-BIN	4C14S-3P φ (1 PL4, 2 PL5)	4C14S-2P (2 PL6)
# Mailboxes (Total)	26	13	12	6	0	0	0	0
# Parcel Lockers (Total)	0	0	0	0	0	0	3	2
# Collection	1	1	1	1	1	0	0	1
# BINS	0	0	0	0	0	2	0	0
# Mailboxes Under 48"	18	9	8	4	0	0	0	0
Module Weight (lbs)	145	101	76	56	72	58	56	55

### NOTES:

All standard 4C mailbox modules shown above are fully configurable; visit [florencemailboxes.com/configure](http://florencemailboxes.com/configure) to quickly and easily create your custom solution.  
See page 12 for mailbox (MB) and parcel locker (PL) compartment size definitions and configurable options.  
Modules noted with (\*) do not meet USPS installation specifications and are for private delivery; those noted with (φ) contain PL under the USPS required 15" tall - see page 12 for details.  
Modules noted with a plus (+) meet Fair Housing ADA installation requirements.  
All model numbers listed are for recessed-mount modules; add -P for Pedestal-mount modules at the end of the number.



# 13 DOOR HIGH SUITE

Actual: 47-3/4"H x 31-9/16"W (Double) or 17-1/2"W (Single) x 17"D  
Rough Opening: 46-13/16"H x 30-5/16"W (Double) or 16-1/4"W (Single) x 17"D

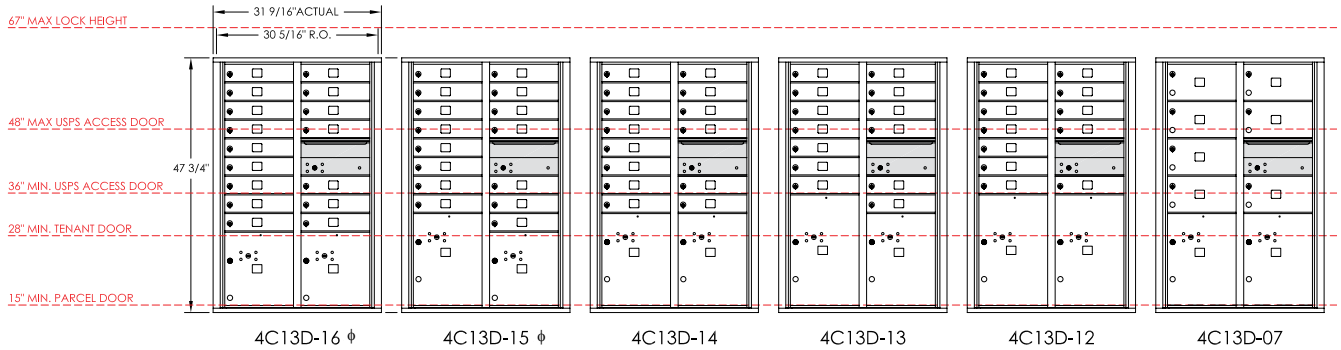

Floor

MODEL (COMPARTMENT TYPES)	4C13D-16 φ (16 MB1, 2 PL4)	4C13D-15 φ (15 MB1, 1 PL 4, 1 PL5)	4C13D-14 (14 MB1, 2 PL5)	4C13D-13 (13 MB1, 1 PL5, 1 PL6)	4C13D-12 (12 MB1, 2 PL6)	4C13D-07 (7 MB2, 2 PL5)
# Mailboxes (Total)	16	15	14	13	12	7
# Parcel Lockers (Total)	2	2	2	2	2	2
# Collection	1	1	1	1	1	1
# BINS	0	0	0	0	0	0
# Mailboxes Under 48"	10	9	8	7	6	3
Module Weight (lbs)	129	127	125	123	121	114

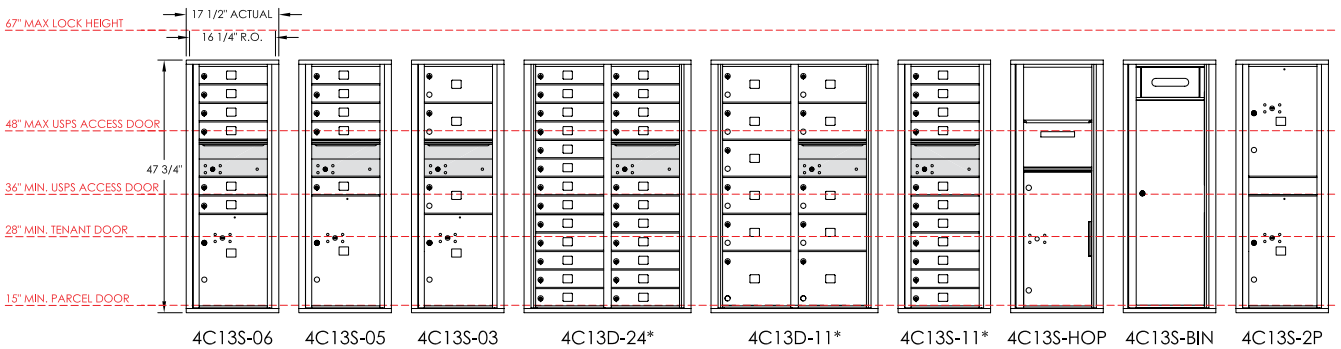

Floor

MODEL (COMPARTMENT TYPES)	4C13S-06 (6 MB1, 1 PL5)	4C13S-05 (5 MB1, 1 PL6)	4C13S-03 (3 MB2, 1 PL5)	4C13D-24* (24 MB1)	4C13D-11* (9 MB2, 2 MB3)	4C13S-11* (11 MB1)	4C13S-HOP	4C13S-BIN	4C13S-2P (2 PL6)
# Mailboxes (Total)	6	5	3	24	11	11	0	0	0
# Parcel Lockers (Total)	1	1	1	0	0	0	0	0	2
# Collection	1	1	1	1	1	1	1	0	0
# BINS	0	0	0	0	0	0	0	1	0
# Mailboxes Under 48"	3	2	1	18	7	8	0	0	0
Module Weight (lbs)	68	67	64	133	112	72	69	45	57

## NOTES:

All standard 4C mailbox modules shown above are fully configurable; visit [florencemailboxes.com/configure](http://florencemailboxes.com/configure) to quickly and easily create your custom solution.  
See page 12 for mailbox (MB) and parcel locker (PL) compartment size definitions and configurable options.  
Modules noted with (\*) do not meet USPS installation specifications and are for private delivery; those noted with (φ) contain PL under the USPS required 15" tall - see page 12 for details.  
Modules noted with a plus (+) meet Fair Housing ADA installation requirements.  
All model numbers listed are for recessed-mount modules; add -P for Pedestal-mount modules at the end of the number.

## 12 DOOR HIGH SUITE

Actual: 44-1/4"H x 31-9/16"W (Double) or 17-1/2"W (Single) x 17"D  
Rough Opening: 43-5/16"H x 30-5/16"W (Double) or 16-1/4"W (Single) x 17"D

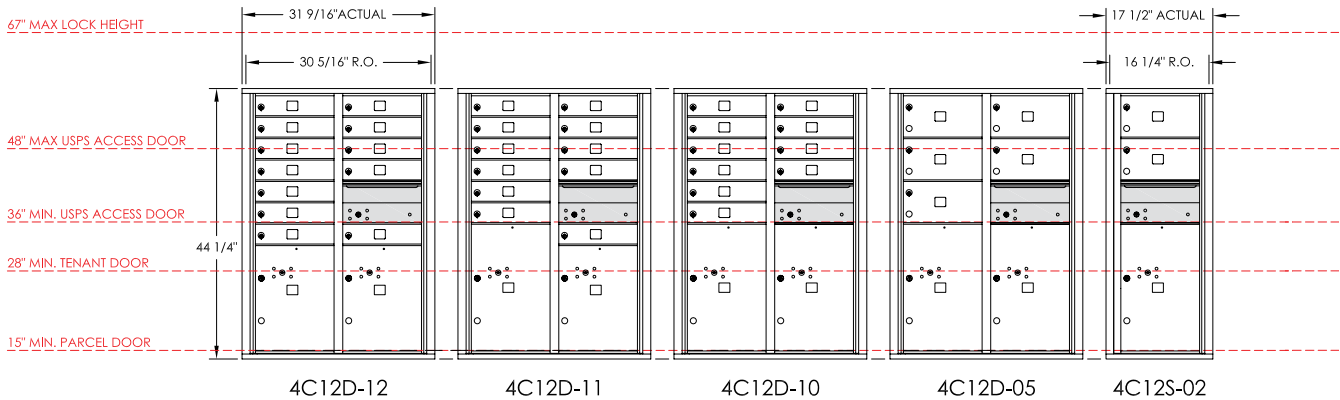

Floor

MODEL (COMPARTMENT TYPES)	4C12D-12 (12 MB1, 2 PL5)	4C12D-11 (11 MB1, 1 PL5, 1 PL6)	4C12D-10 (10 MB1, 2 PL6)	4C12D-05 (5 MB2, 2 PL6)	4C12S-02 (2 MB2, 1 PL6)
# Mailboxes (Total)	12	11	10	5	2
# Parcel Lockers (Total)	2	2	2	2	1
# Collection	1	1	1	1	1
# BINS	0	0	0	0	0
# Mailboxes Under 48"	8	7	6	3	1
Module Weight (lbs)	116	114	112	104	59

67" MAX LOCK HEIGHT

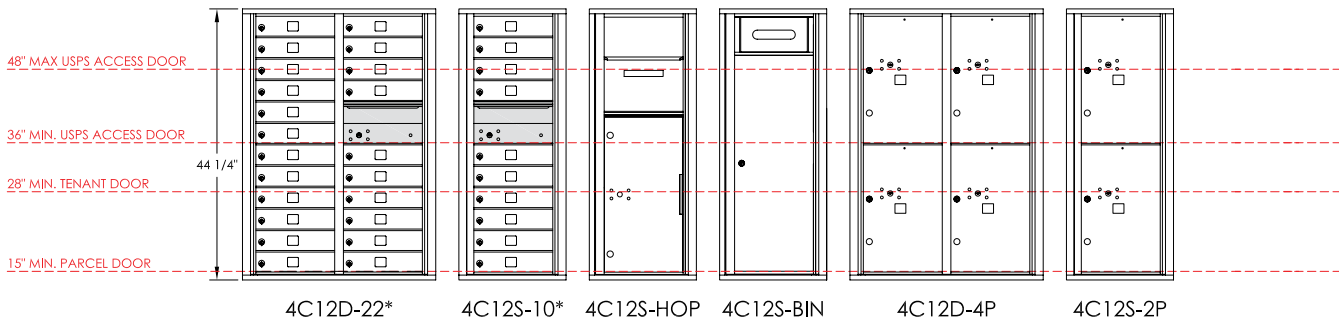

Floor

MODEL (COMPARTMENT TYPES)	4C12D-22* (22 MB1)	4C12S-10* (10 MB1)	4C12S-HOP	4C12S-BIN	4C12D-4P (4 PL6)	4C12S-2P (2 PL6)
# Mailboxes (Total)	22	10	0	0	0	0
# Parcel Lockers (Total)	0	0	0	0	4	2
# Collection	1	1	1	0	0	0
# BINS	0	0	0	1	0	0
# Mailboxes Under 48"	18	8	0	0	0	0
Module Weight (lbs)	124	68	66	45	97	53

### NOTES:

All standard 4C mailbox modules shown above are fully configurable; visit [florencemailboxes.com/configure](http://florencemailboxes.com/configure) to quickly and easily create your custom solution.

See page 12 for mailbox (MB) and parcel locker (PL) compartment size definitions and configurable options.

Modules noted with (\*) do not meet USPS installation specifications and are for private delivery; those noted with (φ) contain PL under the USPS required 15" tall - see page 12 for details.

Modules noted with a plus (+) meet Fair Housing ADA installation requirements.

All model numbers listed are for recessed-mount modules; add -P for Pedestal-mount modules at the end of the number.

versatile™  
4C mailboxes &  
parcel lockers

## 11 DOOR HIGH SUITE

Actual: 40-3/4"H x 31-9/16"W (Double) or 17-1/2"W (Single) x 17"D

Rough Opening: 39-13/16"H x 30-5/16"W (Double) or 16-1/4"W (Single) x 17"D

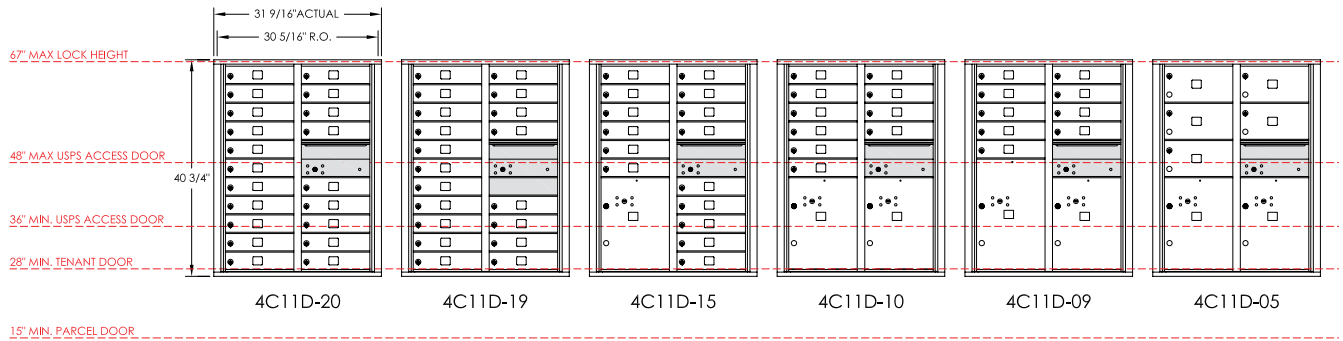

Floor

MODEL (COMPARTMENT TYPES)	4C11D-20 (20 MB1)	4C11D-19 (19 MB1)	4C11D-15 (15 MB1, 1 PL5)	4C11D-10 (10 MB1, 2 PL5)	4C11D-09 (9 MB1, 1 PL5, 1 PL6)	4C11D-05 (5 MB2, 2 PL5)
# Mailboxes (Total)	20	19	15	10	9	5
# Parcel Lockers (Total)	0	0	1	2	2	2
# Collection	1	1	1	1	1	1
# BINS	0	0	0	0	0	0
# Mailboxes Under 48"	11	10	6	1	0	0
Module Weight (lbs)	123	122	119	115	113	106



Floor

MODEL (COMPARTMENT TYPES)	4C11S-09 (9 MB1)	4C11S-04 (4 MB1, 1 PL5)	4C11S-02 (2 MB2, 1 PL5)	4C11S-HOP	4C11S-BIN	4C11D-4P (2 PL5, 2 PL6)	4C11S-2P (1 PL5, 1 PL6)
# Mailboxes (Total)	9	4	2	0	0	0	0
# Parcel Lockers (Total)	0	1	1	0	0	4	2
# Collection	1	1	1	1	0	0	0
# BINS	0	0	0	0	1	0	0
# Mailboxes Under 48"	5	0	0	0	0	0	0
Module Weight (lbs)	56	53	50	65	45	99	45

### NOTES:

All standard 4C mailbox modules shown above are fully configurable; visit [florencemailboxes.com/configure](http://florencemailboxes.com/configure) to quickly and easily create your custom solution.

See page 12 for mailbox (MB) and parcel locker (PL) compartment size definitions and configurable options.

Modules noted with (\*) do not meet USPS installation specifications and are for private delivery; those noted with (φ) contain PL under the USPS required 15" tall - see page 12 for details.

Modules noted with a plus (+) meet Fair Housing ADA installation requirements.

All model numbers listed are for recessed-mount modules; add -P for Pedestal-mount modules at the end of the number.



versatile™  
4C mailboxes &  
parcel lockers

## 10 DOOR HIGH SUITE

Actual: 37-1/4"H x 31-9/16"W (Double) or 17-1/2"W (Single) x 17"D  
Rough Opening: 36-5/16"H x 30-5/16"W (Double) or 16-1/4"W (Single) x 17"D

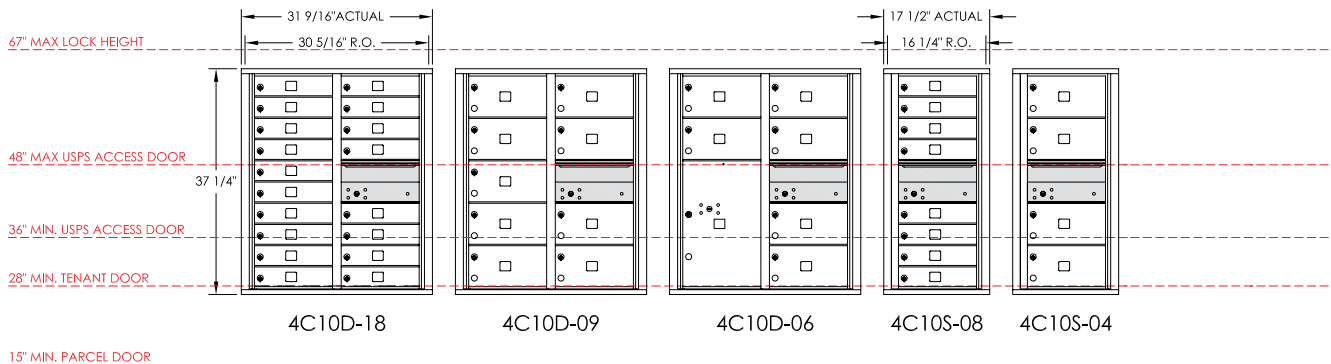

Floor

MODEL (COMPARTMENT TYPES)	4C10D-18 (18 MB1)	4C10D-09 (9 MB2)	4C10D-06 (6 MB2, 1 PL6)	4C10S-08 (8 MB1)	4C10S-04 (4 MB2)
# Mailboxes (Total)	18	9	6	8	4
# Parcel Lockers (Total)	0	0	1	0	0
# Collection	1	1	1	1	1
# BINS	0	0	0	0	0
# Mailboxes Under 48"	10	5	2	4	2
Module Weight (lbs)	97	84	83	56	47

67" MAX LOCK HEIGHT

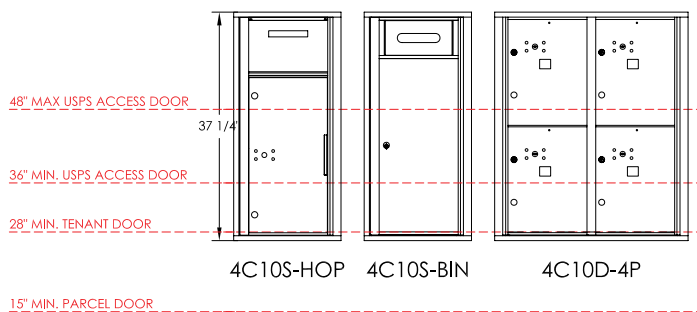

Floor

MODEL (COMPARTMENT TYPES)	4C10S-HOP	4C10S-BIN	4C10D-4P (4 PL5)
# Mailboxes (Total)	0	0	0
# Parcel Lockers (Total)	0	0	4
# Collection	1	0	0
# BINS	0	1	0
# Mailboxes Under 48"	0	0	0
Module Weight (lbs)	41	52	80

## Mailbox Configurator

Florence offers an industry unique online Revit mailbox configurator you can use to create your own versatile™ 4C installation.

This drag and drop tool will help guide you step-by-step, provide you with BIM and/or CAD drawings of your creation, and give you the ability to submit it for a quote.

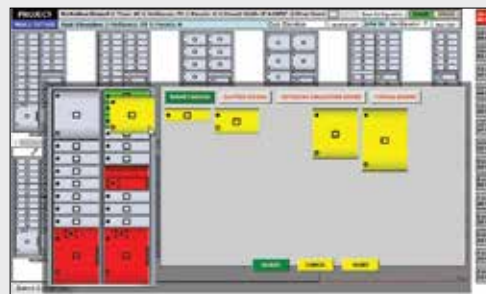

 [florencemailboxes.com/configure](https://florencemailboxes.com/configure)

### NOTES:

All standard 4C mailbox modules shown above are fully configurable; visit [florencemailboxes.com/configure](https://florencemailboxes.com/configure) to quickly and easily create your custom solution.

See page 12 for mailbox (MB) and parcel locker (PL) compartment size definitions and configurable options.

Modules noted with (\*) do not meet USPS installation specifications and are for private delivery; those noted with (φ) contain PL under the USPS required 15" tall - see page 12 for details.

Modules noted with a plus (+) meet Fair Housing ADA installation requirements.

All model numbers listed are for recessed-mount modules; add -P for Pedestal-mount modules at the end of the number.

## 10 DOOR HIGH / ADA MAX SUITE

Actual: 37-1/4"H x 31-9/16"W (Double) or 17-1/2"W (Single) x 17"D

Rough Opening: 36-5/16"H x 30-5/16"W (Double) or 16-1/4"W (Single) x 17"D

67" MAX LOCK HEIGHT

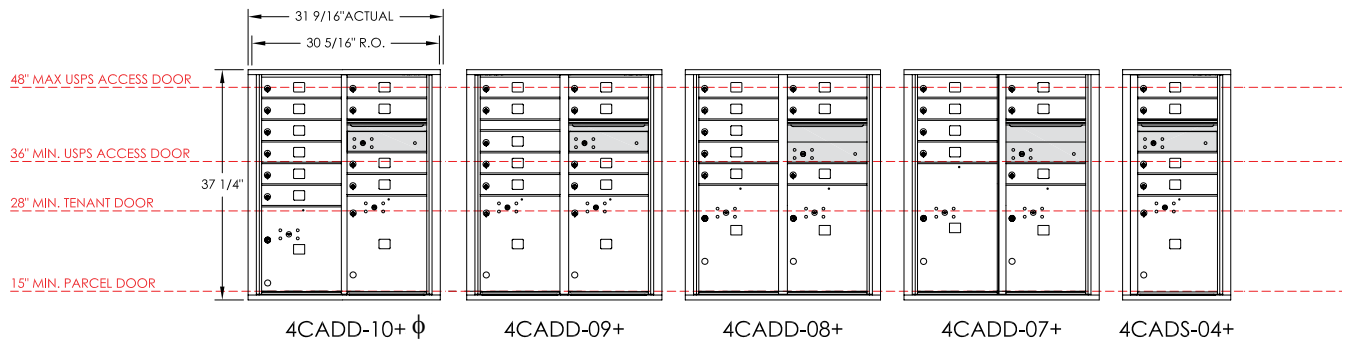

Floor

MODEL (COMPARTMENT TYPES)	4CADD-10+ φ (10 MB1, 1 PL4, 1 PL15)	4CADD-09+ (9 MB1, 2 PL15)	4CADD-08+ (8 MB1, 2 PL5)	4CADD-07+ (7 MB1, 1 PL5, 1 PL6)	4CADD-04+ (4 MB1, 1 PL15)
# Mailboxes (Total)	10	9	8	7	4
# Parcel Lockers (Total)	2	2	2	2	1
# Collection	1	1	1	1	1
# BINS	0	0	0	0	0
# Mailboxes Under 48"	10	9	8	7	4
Module Weight (lbs)	91	96	88	89	55

67" MAX LOCK HEIGHT

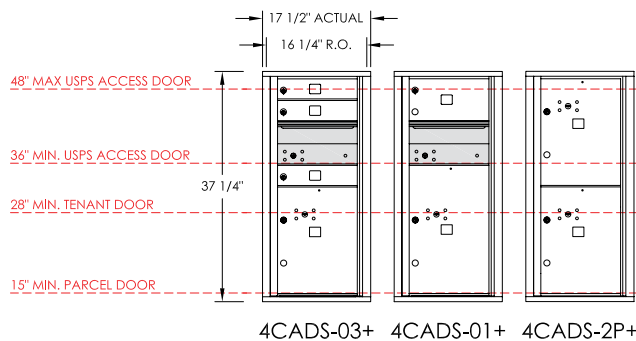

Floor

MODEL (COMPARTMENT TYPES)	4CADS-03+ (3 MB1, 1 PL5)	4CADS-01+ (1 MB2, 1 PL6)	4CADS-2P+ (2 PL5)
# Mailboxes (Total)	3	1	0
# Parcel Lockers (Total)	1	1	2
# Collection	1	1	0
# BINS	0	0	0
# Mailboxes Under 48"	3	1	0
Module Weight (lbs)	49	46	43

### Designing Compliant Mailrooms

For interior mailrooms, the ADA specifies that at least 5% of the total mailboxes must meet accessibility guidelines with installation heights 15" to 48".

Local regulations may override this percentage and require 100% compliance. Typically, it is the local jurisdiction codes office/inspector that will designate if an installation must meet only the minimum ADA requirement of 5% or if it should be 100% compliant.

See page 32 for additional guidelines.

ADA Standards, Section 228.2



#### NOTES:

All standard 4C mailbox modules shown above are fully configurable; visit [florencemailboxes.com/configure](http://florencemailboxes.com/configure) to quickly and easily create your custom solution.

See page 12 for mailbox (MB) and parcel locker (PL) compartment size definitions and configurable options.

Modules noted with (\*) do not meet USPS installation specifications and are for private delivery; those noted with (φ) contain PL under the USPS required 15" tall - see page 12 for details.

Modules noted with a plus (+) meet Fair Housing ADA installation requirements.

All model numbers listed are for recessed-mount modules; add -P for Pedestal-mount modules at the end of the number.

**versatile™**  
4C mailboxes &  
parcel lockers

## 9 DOOR HIGH SUITE

Actual: 33-3/4"H x 31-9/16"W (Double) or 17-1/2"W (Single) x 17"D  
Rough Opening: 32-13/16"H x 30-5/16"W (Double) or 16-1/4"W (Single) x 17"D

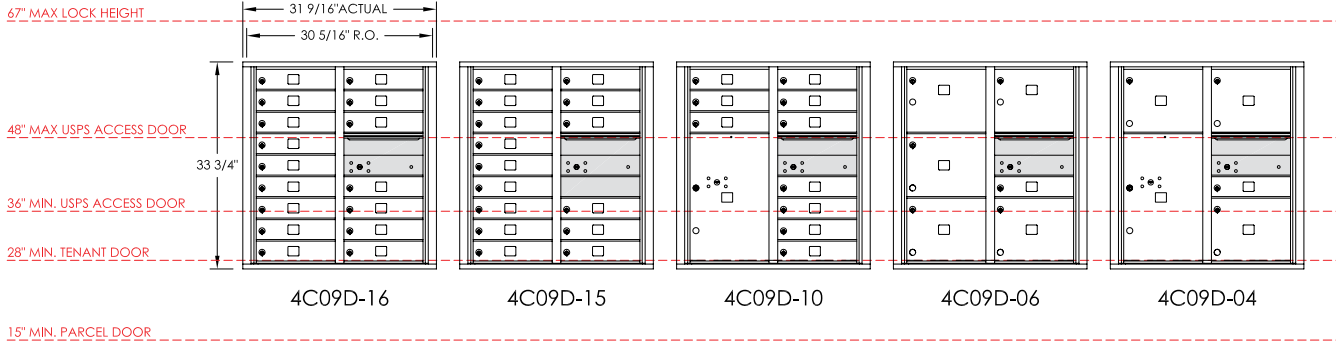

Floor

MODEL (COMPARTMENT TYPES)	4C09D-16 (16 MB1)	4C09D-15 (15 MB1)	4C09D-10 (10 MB1, 1 PL6)	4C09D-06 (1 MB1, 5 MB3)	4C09-04 (1 MB1, 3 MB3, 1 PL6)
# Mailboxes (Total)	16	15	10	6	4
# Parcel Lockers (Total)	0	0	1	0	1
# Collection	1	1	1	1	1
# BINS	0	0	0	0	0
# Mailboxes Under 48"	10	9	4	4	2
Module Weight (lbs)	89	88	84	75	76



Floor

MODEL (COMPARTMENT TYPES)	4C09S-07 (7 MB1)	4C09S-02 (2 MB1, 1 PL5)	4C09S-HOP	4C09S-BIN	4C09D-4P φ (2 PL4, 2 PL5)	4C09S-2P φ (1 PL4, 1 PL5)
# Mailboxes (Total)	7	2	0	0	0	0
# Parcel Lockers (Total)	0	1	0	0	4	2
# Collection	1	1	1	0	0	0
# BINS	0	0	0	1	0	0
# Mailboxes Under 48"	4	0	0	0	0	0
Module Weight (lbs)	48	45	52	41	76	40

### NOTES:

All standard 4C mailbox modules shown above are fully configurable; visit [florencemailboxes.com/configure](http://florencemailboxes.com/configure) to quickly and easily create your custom solution.

See page 12 for mailbox (MB) and parcel locker (PL) compartment size definitions and configurable options.

Modules noted with (\*) do not meet USPS installation specifications and are for private delivery; those noted with (φ) contain PL under the USPS required 15" tall - see page 12 for details. Modules noted with a plus (+) meet Fair Housing ADA installation requirements.

All model numbers listed are for recessed-mount modules; add -P for Pedestal-mount modules at the end of the number.

## 8 DOOR HIGH SUITE

Actual: 30-1/4”H x 31-9/16”W (Double) or 17-1/2”W (Single) x 17”D

Rough Opening: 29-5/16”H x 30-5/16”W (Double) or 16-1/4”W (Single) x 17”D

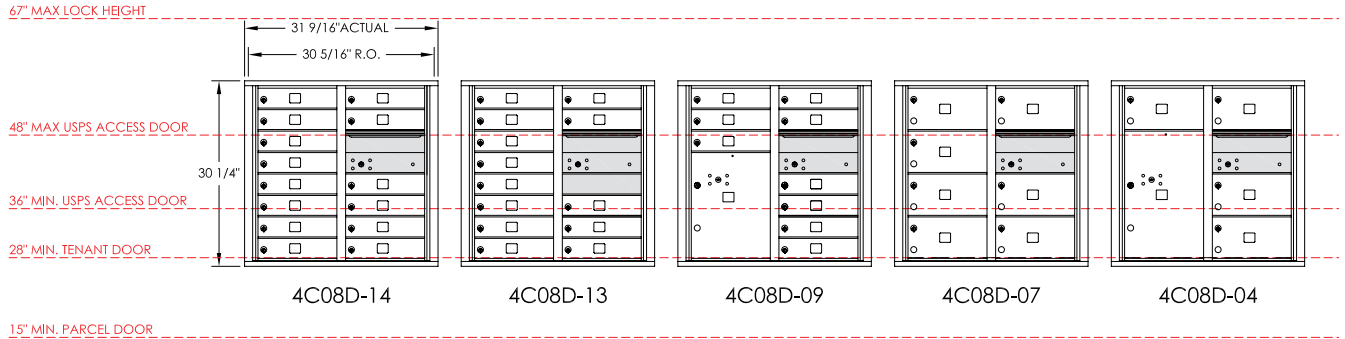

Floor

MODEL (COMPARTMENT TYPES)	4C08D-14 (14 MB1)	4C08D-13 (13 MB1)	4C08D-09 (9 MB1, 1 PL5)	4C08D-07 (7 MB2)	4C08D-04 (4 MB2, 1 PL6)
# Mailboxes (Total)	14	13	9	7	4
# Parcel Lockers (Total)	0	0	1	0	1
# Collection	1	1	1	1	1
# BINS	0	0	0	0	0
# Mailboxes Under 48”	10	9	5	5	2
Module Weight (lbs)	81	80	78	72	71



Floor

MODEL (COMPARTMENT TYPES)	4C08S-06 (6 MB1)	4C08S-03 (3 MB2)	4C08S-01 (1 MB1, 1 PL5)	4C08S-HOP	4C08S-BIN	4C08S-2P φ (1 PL3, 1 PL5)
# Mailboxes (Total)	6	3	1	0	0	0
# Parcel Lockers (Total)	0	0	1	0	0	2
# Collection	1	1	1	1	0	0
# BINS	0	0	0	0	1	0
# Mailboxes Under 48”	4	2	0	0	0	0
Module Weight (lbs)	44	40	40	52	44	37

### NOTES:

All standard 4C mailbox modules shown above are fully configurable; visit [florencemailboxes.com/configure](http://florencemailboxes.com/configure) to quickly and easily create your custom solution.

See page 12 for mailbox (MB) and parcel locker (PL) compartment size definitions and configurable options.

Modules noted with (\*) do not meet USPS installation specifications and are for private delivery; those noted with (φ) contain PL under the USPS required 15” tall - see page 12 for details.

Modules noted with a plus (+) meet Fair Housing ADA installation requirements.

All model numbers listed are for recessed-mount modules; add -P for Pedestal-mount modules at the end of the number.



**versatile™**  
4C mailboxes &  
parcel lockers

## 7 DOOR HIGH SUITE

Actual: 26-3/4"H x 31-9/16"W (Double) or 17-1/2"W (Single) x 17"D  
Rough Opening: 25-13/16"H x 30-5/16"W (Double) or 16-1/4"W

67" MAX LOCK HEIGHT

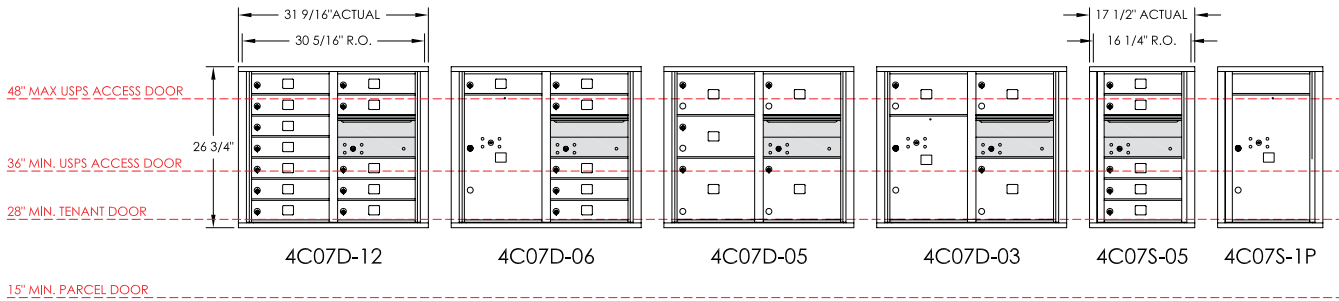

Floor

MODEL (COMPARTMENT TYPES)	4C07D-12 (12 MB1)	4C07D-06 (6 MB1, 1 PL6)	4C07D-05 (3 MB2, 2 MB3)	4C07D-03 (2 MB2, 1 MB3, 1 PL5)	4C07S-05 (5 MB1)	4C07S-1P (1 PL6)
# Mailboxes (Total)	12	6	5	3	5	0
# Parcel Lockers (Total)	0	1	0	1	0	1
# Collection	1	1	1	1	1	0
# BINS	0	0	0	0	0	0
# Mailboxes Under 48"	10	4	3	1	4	0
Module Weight (lbs)	73	68	64	65	40	32

### NOTES:

All standard 4C mailbox modules shown above are fully configurable; visit [florencemailboxes.com/configure](http://florencemailboxes.com/configure) to quickly and easily create your custom solution.

See page 12 for mailbox (MB) and parcel locker (PL) compartment size definitions and configurable options.

Modules noted with (\*) do not meet USPS installation specifications and are for private delivery; those noted with (ϕ) contain PL under the USPS required 15" tall - see page 12 for details.

Modules noted with a plus (+) meet Fair Housing ADA installation requirements.

All model numbers listed are for recessed-mount modules; add -P for Pedestal-mount modules at the end of the number.



## 6 DOOR HIGH SUITE

Actual: 23-1/4"H x 31-9/16"W (Double) or 17-1/2"W (Single) x 17"D

Rough Opening: 22-5/16"H x 30-5/16"W (Double) or 16-1/4"W (Single) x 17"D

67" MAX LOCK HEIGHT

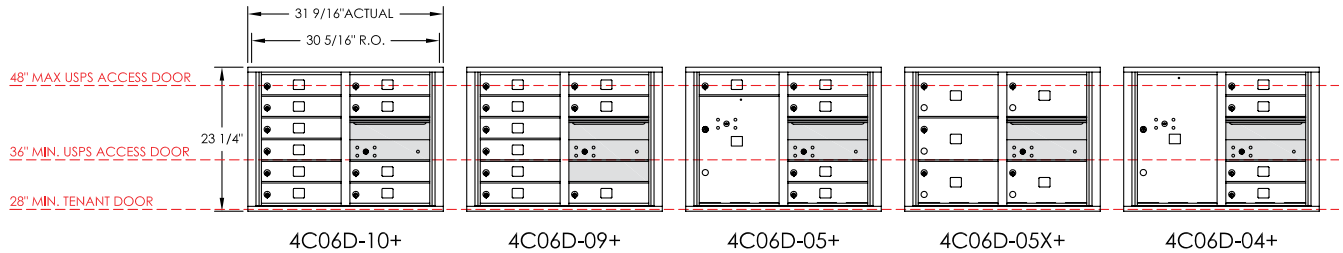

15" MIN. PARCEL DOOR

Floor

MODEL (COMPARTMENT TYPES)	4C06D-10+ (10 MB1)	4C06D-09+ (9 MB1)	4C06D-05+ (5 MB1, 1 PL5)	4C06D-05X+ (5 MB2)	4C06D-04+ (4 MB1, 1 PL6)
# Mailboxes (Total)	10	9	5	5	4
# Parcel Lockers (Total)	0	0	1	0	1
# Collection	1	1	1	1	1
# Mailboxes Under 48"	10	9	5	5	4
Module Weight (lbs)	66	65	59	62	61

67" MAX LOCK HEIGHT

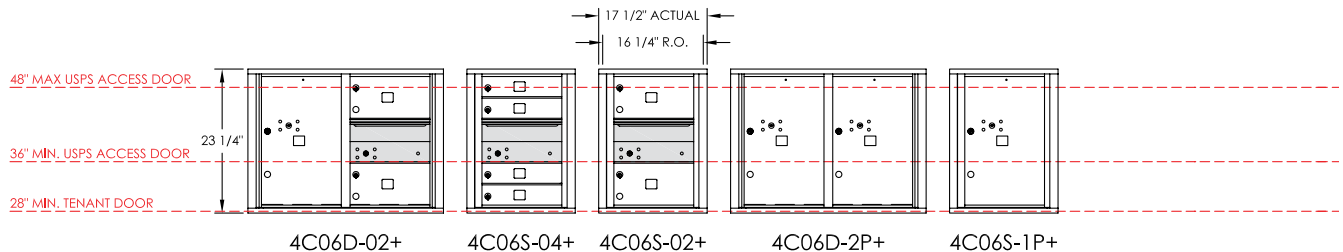

15" MIN. PARCEL DOOR

Floor

MODEL (COMPARTMENT TYPES)	4C06D-02+ (2 MB2, 1 PL6)	4C06S-04+ (4 MB1)	4C06S-02+ (2 MB2)	4C06D-2P+ (2 PL6)	4C06S-1P+ (1 PL6)
# Mailboxes (Total)	2	4	2	0	0
# Parcel Lockers (Total)	1	0	0	2	1
# Collection	1	1	1	0	0
# Mailboxes Under 48"	2	4	2	0	0
Module Weight (lbs)	58	36	33	53	28

### NOTES:

All standard 4C mailbox modules shown above are fully configurable; visit [florencemailboxes.com/configure](http://florencemailboxes.com/configure) to quickly and easily create your custom solution.

See page 12 for mailbox (MB) and parcel locker (PL) compartment size definitions and configurable options.

Modules noted with (\*) do not meet USPS installation specifications and are for private delivery; those noted with (φ) contain PL under the USPS required 15" tall - see page 12 for details.

Modules noted with a plus (+) meet Fair Housing ADA installation requirements.

All model numbers listed are for recessed-mount modules; add -P for Pedestal-mount modules at the end of the number.

## Installation and Accessibility References

Designing appropriate accessibility into every feature of a facility is a key consideration for any project, and how the mailboxes are installed into that facility is no exception. Plus, all wall-mounted mailboxes which will be serviced by the U.S. Postal Service (USPS) must also be installed according to specifications as outlined in the USPS STD-4C regulation.

To assist you with selecting mailboxes that meet the specific requirements of your project, details related to installed heights are noted on the Florence versatile™ 4C mailbox modules references on pages 20-31. Below are also the quick references related to accessible uses and USPS requirements to help you in determining your project layout and design.

### MEETING USPS INSTALLATION REQUIREMENTS

Florence Corporation USPS Approved 4C mailbox products are designed to adhere to STD-4C regulations. To ensure your project complies with USPS regulations for wall-mounted mailboxes, your mailbox center must be installed according to the following U.S. Postal Service guidelines:

#### Installation requirements specified in the U.S. Postal Service STD-4C regulation are outlined below:

1. At least one customer compartment shall be positioned less than 48 inches above the finished floor.
2. No parcel locker compartment (interior bottom shelf) shall be positioned less than 15 inches above the finished floor.
3. No customer lock shall be located more than 67 inches above the finished floor.
4. No customer compartment (interior bottom shelf) shall be positioned less than 28 inches above the finished floor.
5. The USPS Arrow lock shall be located between 36 and 48 inches above the finished floor.

Standards Governing the Design of Wall-Mounted Centralized Mail Receptacles. Federal Register/Vol. 69, No 171/September 3, 2004

Rules and Regulations POSTAL SERVICE, 39 CFR Part 111. [www.gpo.gov/fdsys/pkg/FR-2004-09-03/pdf/04-19781.pdf](http://www.gpo.gov/fdsys/pkg/FR-2004-09-03/pdf/04-19781.pdf)

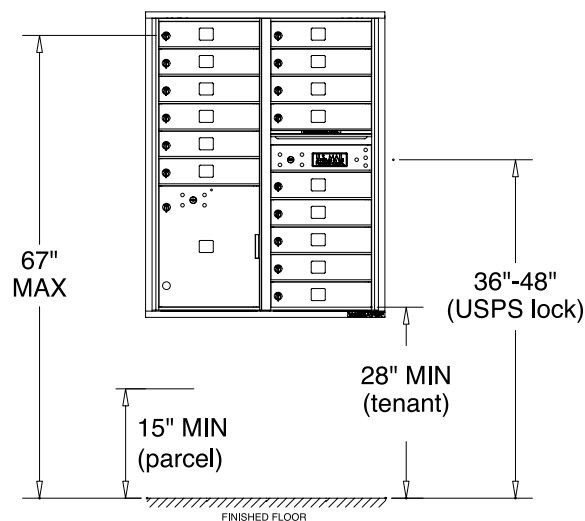

### MEETING ADA INSTALLATION REQUIREMENTS

Accessibility regulations may vary by type of facility and by governing jurisdictions. Therefore, always consult local building officials and codes for applicable accessibility requirements that could affect your mailbox project. Below are industry references for your convenience.

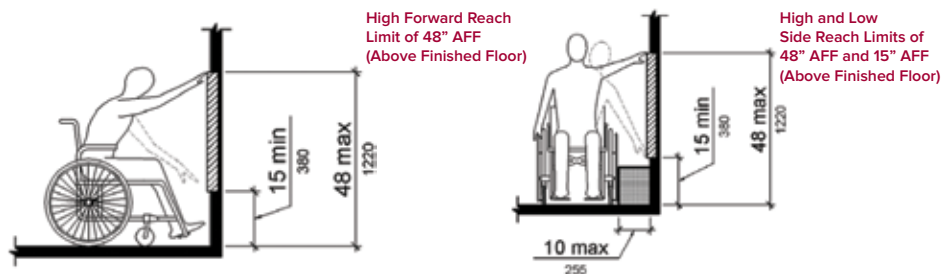

2010 ADA Standards for Accessible Design, Department of Justice Code of Federal Regulations, ADA CHAPTER 2: SCOPING REQUIREMENTS, 228.2 Mail Boxes: Where mail boxes are provided in an interior location, at least 5 percent, but no fewer than one, of each type shall comply with 309. In residential facilities, where mail boxes are provided for each residential dwelling unit, mail boxes complying with 309 shall be provided for each residential dwelling unit required to provide mobility features complying with 809.2 through 809.4.

The full text can be found at: [www.ada.gov/2010ADAstandards\\_index.htm](http://www.ada.gov/2010ADAstandards_index.htm)



Authorized Florence Dealers can help you select the right products that comply with your project requirements.

Visit [www.florencemailboxes.com/dealer-network](http://www.florencemailboxes.com/dealer-network)



## Key Keepers

Key Keepers securely provide access to important keys to only those authorized to use them. Prepared to accept a postal lock installed by local postal officials, key keepers may be converted to locks appropriate for private uses so staff can gain access to controlled areas.

 [florencemailboxes.com/keykeepers](http://florencemailboxes.com/keykeepers)



Model KK



Model KKSM

### STANDARD FEATURES

- Recessed- or surface-mounted
- Prepared for USPS installed master lock
- Anodized aluminum
- Extruded aluminum construction
- Exterior dims: 6-3/4" H x 6-1/4" W x 2-3/8" D
- Interior dims: 4-5/8" H x 4-1/16" W x 2" D
- Rough opening: 5-1/8" H x 4-3/8" W x 2-1/4" D

### OPTIONAL FEATURES

- Private master lock
- Dark Bronze powder coat finish

MODEL	DESCRIPTION
KK#	Recess-mounted key keeper. Prepared for USPS lock.
KK#SM#	Surface-mounted key keeper. Prepared for USPS lock.
KKP#	Recess-mounted key keeper with private lock included.
KKPSM#	Surface-mounted key keeper with private lock included.

Note: Exchange "#" in Model above with A=Anodized Aluminum or DB=Dark Bronze powder coat finish.

## 120 Series Collection Box

Indoor letter collection boxes secure mail until pick up by the USPS.

 [florencemailboxes.com/collection-box](http://florencemailboxes.com/collection-box)

### STANDARD FEATURES

- Front-load, Recessed-mounted
- Prepared for USPS installed master lock
- Anodized aluminum powder coat finish
- Engraved "LETTERS"
- Frame Size: 19-1/8"H x 15-1/6" W
- Rough Opening Size:  
17-5/8" H x 13-5/8" W x 6 -3/4" D

### OPTIONAL FEATURES

- Private master lock available
- Surface-mount collar
- Designated custom engraving
- Dark Bronze powder coat finish



120RA

MODEL	DESCRIPTION
120RA	Fully-recessed collection box is a standard aluminum unit with engraved "LETTERS" prepared for USPS lock.
120SPR	Recessed collection box. Dark Bronze powdercoat finish. Private lock. Specify engraving.
120SMSA	Surface-mounted collection box is a standard aluminum unit with engraved "LETTERS" prepared for USPS lock.
120SPSMS	Surface-mounted collection box. Dark Bronze powdercoat finish. Private lock. Specify engraving.

## Directories

These surface-mounted directories can be used independently or installed next to any mailbox installation to neatly and alphabetically list the names of your residents. A clear plastic window, metal back plate, and blank ruled name cards are included with each directory.

### STANDARD FEATURES

- Anodized aluminum or powder coat finish (color options below)
- Extruded aluminum construction
- 40 name capacity
- D400-1: 19" H x 8-3/4" W



D400-1A



[florencemailboxes.com/directories](http://florencemailboxes.com/directories)

### COLOR OPTIONS

Select either Anodized Aluminum or one of eight different architectural powder coat finishes as noted for all mailbox accessories.

**Antique  
Bronze (AB)**  
PMS 8622C

**Black (BK)**  
PMS Black 6C

**Dark Bronze (DB)**  
PMS Black 7C

**Gold Speck (GS)**  
PMS 7-5C

**Postal Grey (PG)**  
PMS 413C

**Sandstone (SD)**  
PMS 7501C

**Silver Speck (SS)**  
PMS 877C

**White (WH)**  
PMS White

Colors shown are representative of the actual powder coat finish but are limited by printing conditions and may vary slightly from finished product.

## Your Trusted Partner in Commercial and Residential Centralized Mailbox Designs for Over 85 Years!

Like all great stories, ours started in a garage. Elbow grease, a sweaty brow. It's that kind of story. More than 85 years later, we're still hard at it; continually perfecting our craft, allowing you to perfect yours. You may take our products for granted. We take that as a compliment. Our products don't require attention or fuss. They're built smart, designed to work, and engineered to last.

We empower our customers with the products, the support, and the tools to design faster. Build smarter. Manage better. We understand that in a world of global commerce, demands of efficiency and last minute deadlines, you need a partner that can keep pace. You've met your match with Florence. Established. Dependable. Strong. It's not just what we make... it's what makes us.

**FLORENCE**  
CORPORATION  
Established. Dependable. Strong.

800.275.1747

[FlorenceMailboxes.com](http://FlorenceMailboxes.com)

